



# COUNTIS M34/M36

THREE-PHASE AND SINGLE-PHASE DIGITAL ENERGY METERS  
DIRECT CONNECTION 100A



COUNTIS M34 (MID)  
ref. 48C0 3134

COUNTIS M36 (MID)  
ref. 48C0 3136



Certificate of conformity with MID Directive.

www.socomec.com

## Safety instruction

### Information for your own safety

Important Safety Information is contained in the Maintenance section. Familiarize yourself with this information before attempting installation or other procedures. Symbols used in this document:



**Warning**  
This means that failure to observe the instruction can result in death, serious injury or considerable material damage.



**Caution**  
This means hazard of electric shock and failure to take the necessary safety precautions will result in death, serious injury or considerable material damage.

### Proper handling

The equipment (device, module) may only be used for the application specified in the catalogue and the user manual, and only be connected with devices and components recommended and approved by Socomec.

- Use only insulating tools.
- Do not connect while circuit is live (hot).
- Install and use the meter only in a dry, indoor environment.
- Do not mount the meter in an explosive area or expose the meter to dust, mildew and insects.
- Make sure the used wires are suitable for the maximum current of this meter.
- Make sure the AC wires are connected correctly before applying current/voltage to the meter.
- Do not touch the meter connecting clamps directly with your bare hands, with metal, blank wire or other material as you may get an electrical shock.
- Make sure the protection cover is placed after installation.
- Installation, maintenance and reparation should only be done by qualified personnel.
- Never break the seals and open the front cover as this might influence the functionality of the meter, and will avoid any warranty.
- Do not drop, or allow physical impact to the meter as there are high precision components inside that may break.

## Introduction

This document provides operating, maintenance and installation instructions. This device measures and displays the characteristics of single-phase (two-wires, 1P+N), three-phases (3 wires, 3P) and three-phases (4 wires, 3P+N) networks. The measuring parameters include voltage (V), frequency (Hz), current (A), power (kW/kVA/kVA), import, export and total Energy (kWh/kVAh). The unit can also measure Maximum demand of current and power. This is measured over preset periods of up to 60 minutes.

They can measure loads up to 100A direct connection and do not require external current transformers (CT). 2 built-in pulse outputs and either RS485 Modbus or M-bus communication. Configuration is password protected.

## Characteristics

This series covers 2 models

Model	Current Input	Communication	MID
COUNTIS M34	Direct connect 100 A	RS485 Modbus	•
COUNTIS M36	Direct connect 100 A	M-Bus EN 13757-3	•

## RS485 Serial-Modbus RTU

\*For COUNTIS M34

The meter provides a RS485 port for remote communication. Modbus RTU is the protocol applied. For Modbus RTU, the following RS485 communication parameters can be configured from the set-up menu :  
Baud rate: 2400, 4800, 9600, 19200, 38400 bps (default : 9600)  
Parity: NONE/EVEN/ODD (default : none)  
Stop bits: 1 or 2 (default : 1)  
Modbus Address: 1 to 247 (default : 001)

## M-bus

\*For COUNTIS M36

The meter provides an M-Bus port for remote communication. The protocol fully complies with EN13757-3. The following communication parameters can be configured :  
Baud rate: 300, 600, 1200, 2400, 4800, 9600bps (default : 2400)  
Parity: NONE/EVEN/ODD (default : none)  
Stop bits: 1 or 2 (default : 1)  
M-Bus network primary address: 3 digits number from 001 to 250  
M-Bus network secondary address: 00 00 00 00 to 99 99 99 99 (default : serial number of the meter)  
Communication tables can be downloaded on the Socomec website

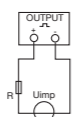

### ATTENTION!

Pulse output must be fed as shown in the wiring diagram on the left. Scrupulously respect polarities and the connection mode. Opto-coupler with potential-free SPST-NO Contact. Contact range: 5-27 VDC / Max. current input: 27mA DC

## Pulse Output 1

Pulse output 1 is configurable. The pulse output 1 can be set to generate pulses to represent total / import/ export kWh or kVAh. The pulse weight can be set to generate 1 pulse per: 0.0025 (default)/0.01/0.1/1/10/100kWh/kVAh. Pulse duration: 200/100(default)/60ms.

## Pulse output 2

Pulse output 2 is non-configurable. It is fixed to total kWh. The pulse weight is 400 pulses per kWh. The Pulse duration is 100ms.

## Start Up Screens

	The first screen lights up all display segments and can be used as a display check.
	Software version information. (The information depicted in the screenshot here is only for example).
	The interface performs a self-test and indicates the result if the test passes.

\*After a short delay, the screen will display active energy information as follows:

	Total active energy in kWh.
--	-----------------------------

## Measurements

	Selects the Voltage, Current and THD display screens. In Set-up Mode, this is the "Left" or "Back" button.
	Select the Frequency, Power factor and max demand display screens. In Set-up Mode, this is the "Up" button.
	Select the Power display screens. In Setup Mode, this is the "Down" button.
	Select the Energy display screens. In Setup mode, this is the "Enter" or "Right" button.

## Voltage and Current

Each successive press of the button selects a new parameter:

	Phase to neutral voltages (1P+N and 3P+N).
	Phase to phase voltages (3P and 3P+N).
	Current on each phase.
	Phase to neutral voltage THD% (1P+N and 3P+N).
	Phase to phase voltage THD% (3P and 3P+N).
	Current THD% for each phase.

## Frequency, Power Factor and Demand

Each successive press of the button selects a new parameter:

	Frequency and Power Factor (total).
	Power Factor of each phase.
	Maximum Current Demand.
	Maximum Power Demand.

## Power

Each successive press of the button selects a new parameter:

	Instantaneous Active Power in kW.
	Instantaneous Reactive Power in kvar.
	Instantaneous Volt-Amps in kVA.
	Total kW, kvar, kVA.

## Energy Measurements

Each successive press of the button selects a new parameter:

	Total Active Energy in kWh.
	Total Reactive Energy in kVAh.
	Import Active Energy in kWh (Ea+).
	Export Active Energy in kWh (Ea-).
	Import Reactive Energy in kVAh (Er+).
	Export Reactive Energy in kVAh (Er-).

## Set Up

To enter set-up mode, press the button for 3 seconds until the password screen appears.

	Setting up is password protected. The user should enter the correct password (default '1000') before proceeding.
	If an incorrect password is entered, the display will show: PASS Err

To exit set-up mode, press repeatedly until the measurement screen is restored.

## Menu Option Selection

1. Use and buttons to scroll through the different options of the set up menu.
2. Press to confirm your selection
3. If an item flashes, then it can be adjusted by the and buttons.
4. Having selected an option, press to confirm your selection.
5. Having completed a parameter setting, press to return to a higher menu level. You will be able to use the and buttons for further menu selection.
6. On completion of all setting-up, press repeatedly until the measurement screen is restored.

## Number Entry Procedure

When setting up the unit, some screens require the entering of a number. In particular, on entry to the set-up section, a password must be entered. Digits are set individually, from left to right. The procedure is as follows:

1. The current digit to be set flashes and is set using the and buttons.
2. Press to confirm each digit setting.
3. After setting the last digit, press to exit the number setting routine.

## Communication

### Modbus or M-bus Primary Address

	(The range is from 001 to 247 for Modbus and 001 to 250 for M-bus)
	From the set-up menu, press  and  buttons to select the address ID.
	Press  button to enter the selection routine. The current setting will flash.
	Use  and  buttons to choose Modbus or M-bus primary address.

Press button to confirm the setting and press button to return the main set-up menu.

### Mbus Secondary Address

\*For COUNTIS M36

	Secondary address: 00 00 00 01 to 99 99 99 99
	From the set-up menu, use  and  buttons to find the setting page.
	Press  to enter the selection routine. The current setting will flash.
	Use  and  buttons to set the secondary address.

Press to confirm the setting and press to return to the main set up menu.



### Baud Rate

Baud rate range for Modbus RTU: 2.4k, 4.8k, 9.6k, 19.2k, 38.4k. For Mbus: 0.3k, 0.6k, 2.4k, 4.8k, 9.6k.

	From the set-up menu, use  and  buttons to select the baud rate option.
	Press  to enter the selection routine. The current setting will flash.
	Use  and  buttons to choose baud rate 2.4k, 4.8k, 9.6k, 19.2k, 38.4k



Press to confirm the setting and press to return to the main set-up menu.

## Parity

	From the set-up menu, use <b>F PF▲</b> and <b>P ▼</b> buttons to select the parity option.
	Press <b>E ↵</b> to enter the selection routine. The current setting will flash.
	Use <b>F PF▲</b> and <b>P ▼</b> buttons to choose parity (EVEN / ODD / NONE (default)).

Press **E ↵** to confirm the setting and press **UI ESC** to return to the main set-up menu.



## Stop Bits

	From the set-up menu, use <b>F PF▲</b> and <b>P ▼</b> buttons to select the stop bit option.
	Press <b>E ↵</b> to enter the selection routine. The current setting will flash.
	Use <b>F PF▲</b> and <b>P ▼</b> buttons to choose stop bit (2 or 1) Note: default is 1, can only be set to 2 if the parity is previously set to NONE.

Press **E ↵** to confirm the setting and press **UI ESC** to return to the main set-up menu.

## Pulse Output

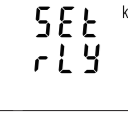

The option allows you to configure the pulse output 1. The output can be set to provide a pulse for a defined amount of active or reactive energy. Use this section to set up the pulse for: Total kWh / Total kVAh - Import kWh / Export kWh - Import kVAh / Export kVAh

	From the set-up menu, use <b>F PF▲</b> and <b>P ▼</b> buttons to select the Pulse Output option.
	Press <b>E ↵</b> to enter the selection routine. The unit symbol will flash.
	Use <b>F PF▲</b> and <b>P ▼</b> buttons to choose kWh or kVAh.

Press **E ↵** to confirm the setting and press **UI ESC** to return to the main set up menu.

## Pulse weight



Use this to set the energy represented by each pulse. Rate can be set to 1 pulse per dFt (0.0025)/0.01/0.1/1/10/100 kWh or kVAh.

	(It shows 1 impulse = 10 kWh or kVAh)
	From the set-up menu, use <b>F PF▲</b> and <b>P ▼</b> buttons to select the pulse rate option.
	Press <b>E ↵</b> to enter the selection routine. The current setting will flash. When it's dFt (default), it means 2.5 Wh or varh.

Use **F PF▲** and **P ▼** buttons to choose pulse rate. Press **E ↵** to confirm the setting and press **UI ESC** to return to the main set up menu.

## Pulse Duration



The pulse duration can be set to 200, 100 (default) or 60ms.

	(It shows pulse width of 100ms)
	From the set-up menu, use <b>F PF▲</b> and <b>P ▼</b> buttons to select the pulse duration option.
	Press <b>E ↵</b> to enter the selection routine. The current setting will flash.

Use **F PF▲** and **P ▼** buttons to choose pulse duration. Press **E ↵** to confirm the setting and press **UI ESC** to return to the main set-up menu.

## DIT Demand Integration Time



This sets the period in minutes over which the current and power readings are integrated for maximum demand measurement. The options are: 0, 5, 8, 10, 15, 20, 30, 60 minutes.

	From the set-up menu, use <b>F PF▲</b> and <b>P ▼</b> buttons to select the DIT option. The screen will show the currently selected integration time.
	Press <b>E ↵</b> to enter the selection routine. The current time interval will flash.
	Use <b>F PF▲</b> and <b>P ▼</b> to select the time required. Press <b>E ↵</b> to confirm your selection.

Use **F PF▲** and **P ▼** buttons to choose the selection. Press **E ↵** to confirm the setting and press **UI ESC** to return to the main set-up menu.

## Backlight Set-up



The meter provides a function to set the backlight lasting time (0/10/30/60/120 minutes). **Option 0 means the backlight will remain always on.**

	Default: 60
	Use <b>F PF▲</b> and <b>P ▼</b> buttons to choose the time.

Press **E ↵** to confirm the setting and press **UI ESC** to return to the main set-up menu.

## Electrical network

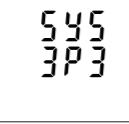

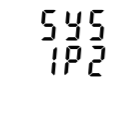
**The unit has a default setting of 3 phases-4wires (3P+N).** Use this section to set the type of electrical network.

	From the set-up menu, use <b>F PF▲</b> and <b>P ▼</b> buttons to select the system option. The screen will show the currently selected system type.
	Press <b>E ↵</b> to enter the selection routine. The current selection will flash.
	Use <b>F PF▲</b> and <b>P ▼</b> buttons to select the required system option: 1P2 : 1 phase + neutral 3P3 : 3 phases without neutral 3P4 : 3 phases with neutral

Press **E ↵** to confirm the selection. Press **UI ESC** to exit the system selection routine and return to the menu.



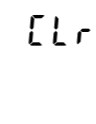



## CLR

The meter provides a function to reset the maximum demand value of current and power.

	From the set-up menu, use <b>F PF▲</b> and <b>P ▼</b> buttons to select the reset option.
	Press <b>E ↵</b> to enter the selection routine. The "MD" will flash.

Press **E ↵** to confirm the reset and press **UI ESC** to return to the main set-up menu.

## Change Password

	Use the <b>F PF▲</b> and <b>P ▼</b> to choose the change password option.
	Use the <b>F PF▲</b> and <b>P ▼</b> to choose the change password option.
	Press the <b>E ↵</b> to enter the change password routine. The new password screen will appear with the first digit flashing.
	Use <b>F PF▲</b> and <b>P ▼</b> to set the first digit and press <b>E ↵</b> to confirm your selection. The next digit will flash.
	Repeat the procedure for the remaining three digits.
	After setting the last digit, Press <b>E ↵</b> to confirm the selection.

Press **UI ESC** to exit the number setting routine and return to the Set-up menu.

## Specifications

### Measured Parameters

The unit can monitor and display the following parameters of a single phase two wires (1P+N), three phase three wires (3P) or three phase four wires (3P+N) system.

### Voltage and Current

- Phase to neutral voltages 100 to 276V a.c. (in case of neutral present).
- Voltages between phases 173 to 480V a.c. (not available in single phase).
- Percentage total voltage harmonic distortion (THD%) for each phase to N (in case of neutral present).
- Percentage voltage THD% between phases (in case of neutral present).
- Current THD% for each phase

### Power Factor, Frequency and Max. Demand

- Frequency in Hz
- Power factor
- Instantaneous power:
  - Power 0 to 99999 W
  - Reactive power 0 to 99999 VAR
- Volt-amps 0 to 99999 VA
- Maximum demand power since last reset
- Maximum neutral current demand, since last Reset (in case of neutral present)

### Energy Measurements

- Import/Export active energy (ea+/ea-) 0 to 999999.99 kWh
- Import/Export reactive energy (er+/er-) 0 to 999999.99 kVAh
- Total active energy 0 to 999999.99 kWh
- Total reactive energy 0 to 999999.99 kVAh

## Technical characteristics

General	
Voltage AC (Un)	3x230 / 400VAC
Voltage range	80%~120% of Un
Base Current	10 A
Max. Current	100 A
Min. Current	0.5 A
Power consumption	<2W/10VA
Frequency	50Hz ±2%
Input waveform	Sinusoidal (distortion factor < 0.005)
AC voltage withstand	4KV for 1 minute
Impulse voltage withstand	6KV~1.2uS waveform
Overcurrent withstand	30Imax for 0.01s
Pulse output 1	configurable : 0.01,0.1,1,10,100,400 pulses per kWh/kVAh
Pulse output 2	non-configurable : 400 pulses per kWh
Display	LCD with white backlight
Max. Reading	999999.99 kWh/kVAh
Accuracy	
Voltage	0.5%
Current	0.5%
Frequency	0.2%
Power factor	1%
Active power	1%
Reactive power	1%
Apparent power	1%
Active energy	Class B EN50470-1/3
Reactive energy	Class 2 IEC 62053-23
Total harmonic distortion	1% up to 31st harmonic
Values refresh rate	1s, typical, to >99% of final reading, at 50 Hz
Environment	
Operating temperature	-40°C to +70°C (3K7)
Storage and transportation temperature	-40°C to +70°C
Reference temperature	23°C ±2°C
Relative humidity	0 to 95%, non-condensing
Altitude	Up to 2000m
Warm up time	3s
Mechanical environment	M1
Electromagnetic environment	E2
Degree of pollution	2
Mechanics	
Din rail dimensions	72 x 100 x 66 mm (WxHxD) DIN 43880
Mounting	DIN rail 35mm
Ingress protection	IP51
Material	Self-extinguishing UL94V-0

## Interfaces for External Monitoring

Three interfaces are provided:

- RS485 Modbus RTU or M-bus for remote communication.
- Pulse output (Pulse 1) indicating real-time measured energy (configurable).
- Pulse output (Pulse 2) 400 pulses per kWh (non-configurable).

The Modbus configuration (baud rate etc.) and the pulse output assignments (kWh / kVAh, import / export etc.) are configured through the set-up screens.

## Dimensions

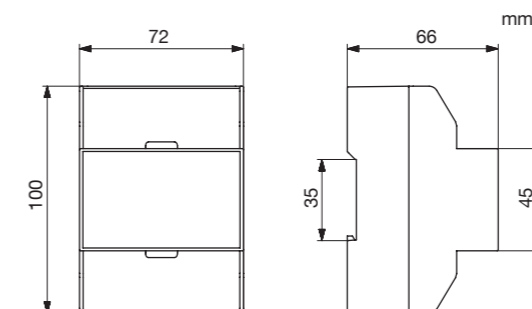

## Wiring diagram

### Single phase 2 wires (1P+N)

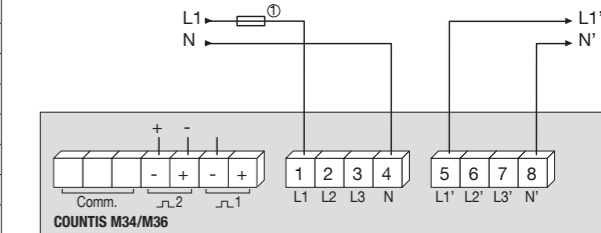

### 3 phases 3 wires (3P)

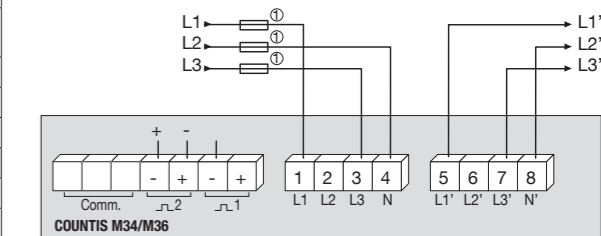

### 3 phases 4 wires (3P+N)

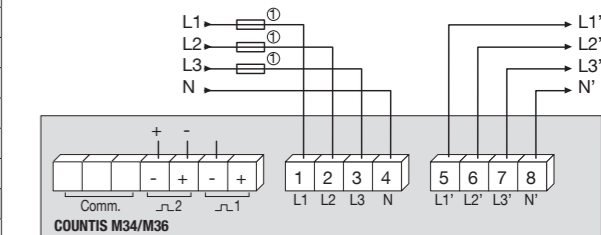

N - L: network input.  
N' - L': network output.

Comm. terminals for RS485: 

Comm. terminals for M-bus: 

© 100 A gG / Am fuses max.

## Cable dimensions and tightening torque

Cables dimensions	COMM / Pulse	0.5~1.5mm <sup>2</sup>
	Load	4~25mm <sup>2</sup>
Tightening torque	COMM / Pulse	0.4Nm
	Load	3Nm

## Declaration of Conformity for the MID approved version meter only



Certificate of conformity with MID Directive.

www.socomec.com



Print: 70 g/m<sup>2</sup> - A3 > A7 - R/V - B&W.  
The bar code must be visible once the document is folded.  
Non contractual document. © 2022, Socomec SAS. All rights reserved.

CORPORATE HQ CONTACT: SOCOMEC SAS,  
1-4 RUE DE WESTHOUSE, 67235 BENFELD, FRANCE.